

**studio** **xps**<sup>™</sup>

**SETUP GUIDE**



**YOURS IS HERE**



**studio** **xps**™

**SETUP GUIDE**

Regulatory model: D03M series

Regulatory type: D03M002

# Notes, Cautions, and Warnings



**NOTE:** A NOTE indicates important information that helps you make better use of your computer.



**CAUTION:** A CAUTION indicates either potential damage to hardware or loss of data and tells you how to avoid the problem.



**WARNING:** A WARNING indicates a potential for property damage, personal injury, or death.

If you purchased a Dell™ n Series computer, any references in this document to Microsoft® Windows® operating systems are not applicable.

---

**Information in this document is subject to change without notice.**

**© 2010 Dell Inc. All rights reserved.**

Reproduction of these materials in any manner whatsoever without the written permission of Dell Inc. is strictly forbidden.

Trademarks used in this text: *Dell*, the *DELL* logo, *YOURS IS HERE*, *Solution Station*, *Studio XPS*, and *DellConnect* are trademarks of Dell Inc.; *AMD*, *AMD Athlon*, and *AMD Phenom* are trademarks of Advanced Micro Devices, Inc.; *Microsoft*, *Windows*, and the *Windows* start button logo are either trademarks or registered trademarks of Microsoft Corporation in the United States and/or other countries; *Blu-ray Disc* is a trademark of the Blu-ray Disc Association; *Bluetooth* is a registered trademark owned by Bluetooth SIG, Inc. and is used by Dell under license.

Other trademarks and trade names may be used in this document to refer to either the entities claiming the marks and names or their products. Dell Inc. disclaims any proprietary interest in trademarks and trade names other than its own.

**March 2010**

**P/N KM04C**

**Rev. A00**

# Contents

|   |           |   |           |
|---|-----------|---|-----------|
| <b>Setting Up Your Studio XPS Desktop</b> . . . . .     | <b>5</b>  | Top View Features . . . . .             | 24        |
| Lifting Your Computer . . . . .                         | 6         | Software Features . . . . .             | 26        |
| Before Setting Up Your Computer . . . . .               | 7         | Dell Dock . . . . .                     | 27        |
| Connect the Display . . . . .                           | 8         | Dell DataSafe Online Backup . . . . .   | 28        |
| Connect the Keyboard and Mouse . . . . .                | 10        | <b>Solving Problems</b> . . . . .       | <b>29</b> |
| Connect the Network Cable (Optional) . . . . .          | 11        | Beep Codes . . . . .                    | 29        |
| Connect the Power Cable . . . . .                       | 12        | Network Problems . . . . .              | 30        |
| Press the Power Button . . . . .                        | 12        | Power Problems . . . . .                | 31        |
| Set Up the Operating System . . . . .                   | 13        | Memory Problems . . . . .               | 32        |
| Create System Recovery Media<br>(Recommended) . . . . . | 14        | Lockups and Software Problems . . . . . | 33        |
| Connect to the Internet (Optional) . . . . .            | 15        | <b>Using Support Tools</b> . . . . .    | <b>36</b> |
| <b>Using Your Studio XPS Desktop</b> . . . . .          | <b>18</b> | Dell Support Center . . . . .           | 36        |
| Front View Features . . . . .                           | 18        | My Dell Downloads . . . . .             | 37        |
| Back View Features . . . . .                            | 20        | System Messages . . . . .               | 37        |
| Back Panel Connectors . . . . .                         | 22        | Hardware Troubleshooter . . . . .       | 39        |
|   |           | Dell Diagnostics . . . . .              | 40        |

## Contents

|   |           |   |           |
|---|-----------|---|-----------|
| <b>Restoring Your Operating System</b> .....                  | <b>44</b> | <b>Finding More Information and Resources</b> .....                       | <b>58</b> |
| System Restore .....  | 45        | <b>Specifications</b> .....   | <b>60</b> |
| Dell DataSafe Local Backup .....                              | 46        | <b>Appendix</b> .....   | <b>66</b> |
| System Recovery Media .....                                   | 48        | Macrovision Product Notice .....  | 66        |
| Dell Factory Image Restore .....                              | 49        | Information for NOM, or Official Mexican Standard (only for Mexico) ..... | 67        |
| <b>Getting Help</b> .....                                     | <b>51</b> | <b>Index</b> .....  | <b>68</b> |
| Technical Support and Customer Service .....                  | 52        |   |           |
| DellConnect .....   | 52        |   |           |
| Online Services .....   | 52        |   |           |
| Automated Order-Status Service .....                          | 53        |   |           |
| Product Information .....                                     | 54        |   |           |
| Returning Items for Repair Under Warranty or for Credit ..... | 54        |   |           |
| Before You Call .....   | 56        |   |           |
| Contacting Dell .....   | 57        |   |           |

# Setting Up Your Studio XPS Desktop

This section provides information about setting up your Dell™ Studio XPS™ desktop.



**WARNING:** Before you begin any of the procedures in this section, read the safety information that shipped with your computer. For additional safety best practices information, see the Regulatory Compliance Homepage at [www.dell.com/regulatory\\_compliance](http://www.dell.com/regulatory_compliance).

## Lifting Your Computer

To ensure safety and to avoid any damage to your computer, lift it by holding the lift points in the front and back of your computer.

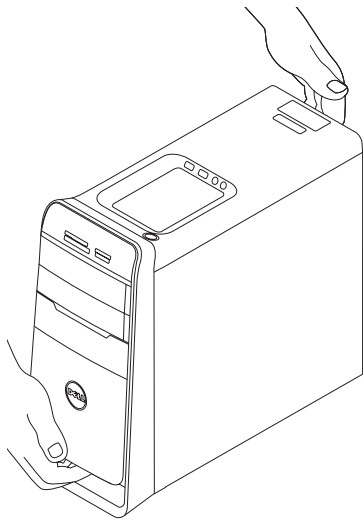



## **Before Setting Up Your Computer**

When positioning your computer, ensure that you allow easy access to a power source, adequate ventilation, and a level surface to place your computer.

Restricting airflow around your computer may cause it to overheat. To prevent overheating ensure that you leave at least 10.2 cm (4 inches) at the back of the computer and a minimum of 5.1 cm (2 inches) on all other sides. You should never place your computer in an enclosed space, such as a cabinet or drawer when it is powered on.











# Connect the Display

Your computer has integrated video connectors. Connect the display using either the integrated HDMI or DVI connector.

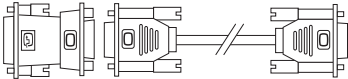
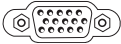
If required, you can purchase the DVI-to-VGA adapter, HDMI-to-DVI adapter, and additional HDMI or DVI cables at [www.dell.com](http://www.dell.com).

Use the appropriate cable based on the connectors available on your computer and display. See the following table to identify the connectors on your computer and display.

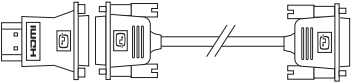
 **NOTE:** When connecting to a single display, connect the display to **ONLY ONE** of the connectors on your computer.

| Connection Type                                     | Computer  | Cable  | Display   |
|---|---|--|---|
| DVI-to-DVI<br>(DVI cable)                           |  |  |  |
| DVI-to-VGA<br>(DVI-to-VGA adapter<br>+ VGA cable)   |  |  |  |
| HDMI-to-HDMI<br>(HDMI cable)                        |  |  |  |
| HDMI-to-DVI<br>(HDMI-to-DVI<br>adapter + DVI cable) |  |  |  |

## Connect the Keyboard and Mouse

Connect the USB keyboard and mouse to the USB connectors on the back panel of your computer.

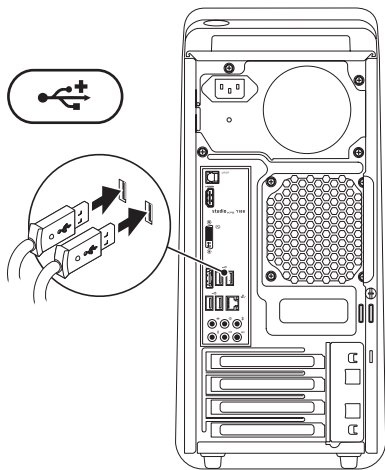

## Connect the Network Cable (Optional)

A network connection is not required to complete your computer setup, but if you have an existing network or Internet connection that uses a cable connection (such as a broadband device or Ethernet jack), you can connect it now.

 **NOTE:** Use only an Ethernet cable to connect to the network connector (RJ45 connector). Do not plug a telephone cable (RJ11 connector) into the network connector.

To connect your computer to a network or a broadband device, connect one end of the network cable to the network port or the broadband device. Connect the other end of the network cable to the network connector (RJ45 connector) on the back panel of your computer. A click indicates that the network cable has been securely attached.

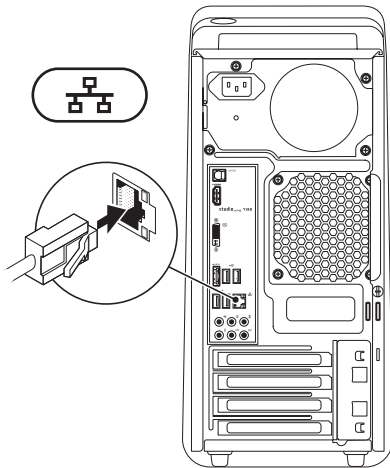

## Connect the Power Cable

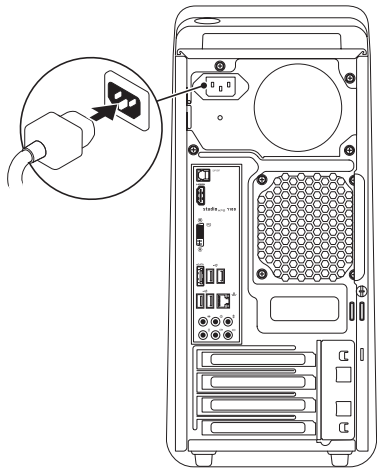

## Press the Power Button

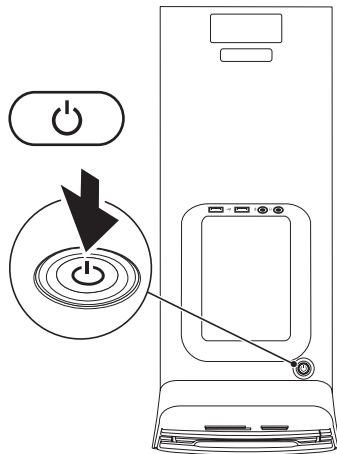



## Set Up the Operating System

Your computer is preconfigured with the operating system you selected at the time of purchase.

### Set Up Microsoft Windows

To set up Microsoft® Windows® for the first time, follow the instructions on the screen. These steps are mandatory and may take some time to complete. The Windows setup screens will take you through several procedures including accepting license agreements, setting preferences, and setting up an Internet connection.

 **CAUTION:** Do not interrupt the operating system's setup process. Doing so may render your computer unusable and you will need to reinstall the operating system.

 **NOTE:** It is recommended that you download and install the latest BIOS and drivers for your computer available at [support.dell.com](http://support.dell.com).

 **NOTE:** For more information on the operating system and features, see [support.dell.com/MyNewDell](http://support.dell.com/MyNewDell).

### Set Up Ubuntu

To set up Ubuntu for the first time, follow the instructions on the screen.

# Create System Recovery Media (Recommended)

 **NOTE:** It is recommended that you create a system recovery media as soon as you set up Microsoft Windows.

The system recovery media can be used to restore your computer to the operating state it was in when you purchased the computer, while preserving data files (without the need of the *Operating System* disc). You can use the system recovery media if changes to the hardware, software, drivers, or other system settings have left the computer in an undesirable operating state.

You will require the following to create the system recovery media:

- Dell DataSafe Local Backup
- USB key with a minimum capacity of 8 GB or DVD-R/DVD+R/Blu-ray Disc™

 **NOTE:** Dell DataSafe Local Backup does not support rewritable discs.

To create a system recovery media:

1. Ensure that the computer is turned on.
2. Insert the disc or USB key in the computer.
3. Click **Start**  → **Programs** → **Dell DataSafe Local Backup**.
4. Click **Create Recovery Media**.
5. Follow the instructions on the screen.

 **NOTE:** For information on using the system recovery media, see “System Recovery Media” on page 48.



## Connect to the Internet (Optional)

To connect to the Internet, you need an external modem or network connection and an Internet service provider (ISP).

If an external USB modem or WLAN adapter is not part of your original order, you can purchase one at [www.dell.com](http://www.dell.com).

## Setting Up a Wired Connection

- If you are using a dial-up connection, connect the telephone line to the external USB modem (optional) and to the telephone wall jack before you set up your Internet connection.
- If you are using a DSL or cable/satellite modem connection, contact your ISP or cellular telephone service for setup instructions.

To complete setting up your wired Internet connection, follow the instructions in “Setting Up Your Internet Connection” on page 16.

### Setting Up a Wireless Connection

 **NOTE:** To set up your wireless router, see the documentation that shipped with your router.

Before you can use your wireless Internet connection, you need to connect to your wireless router.

To set up your connection to a wireless router:

1. Save and close any open files, and exit any open programs.
2. Click **Start**  → **Control Panel**.
3. In the search box, type `network`, and then click **Network and Sharing Center** → **Connect to a network**.
4. Follow the instructions on the screen to complete the setup.

### Setting Up Your Internet Connection

ISPs and ISP offerings vary by country. Contact your ISP for offerings available in your country.

If you cannot connect to the Internet but have successfully connected in the past, the ISP might have a service outage. Contact your ISP to check the service status, or try connecting again later.

Have your ISP information ready. If you do not have an ISP, the **Connect to the Internet** wizard can help you get one.

To set up your Internet connection:

1. Save and close any open files, and exit any open programs.
2. Click **Start**  → **Control Panel**.
3. In the search box, type `network`, and then click **Network and Sharing Center** → **Set up a new connection or network** → **Connect to the Internet**.

The **Connect to the Internet** window appears.



-  **NOTE:** If you do not know which type of connection to select, click **Help me choose** or contact your ISP.
4. Follow the instructions on the screen and use the setup information provided by your ISP to complete the setup.

# Using Your Studio XPS Desktop

This section provides information about the features available on your Studio XPS™ desktop.

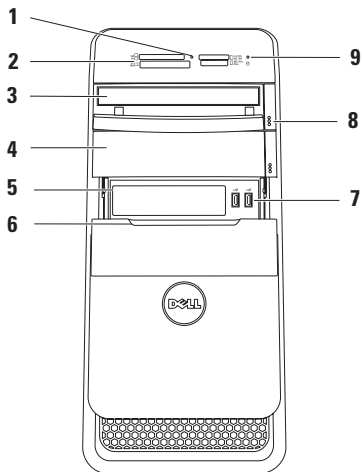
## Front View Features



- 1 Media Card Reader light** — Indicates if a media card is inserted.
  - 2 Media Card Reader** — Provides a fast and convenient way to view and share digital photos, music, and videos stored on a media card.
  - 3 Optical drive** — Plays or records only standard-size (12 cm) CDs, DVDs, and Blu-ray Discs (optional).
  - 4 Optional Optical drive bay** — Can contain an additional optical drive.
  - 5 FlexBay slot** — Can support a Media Card Reader or an additional hard drive.
  - 6 FlexBay cover** — Covers the FlexBay slot.
  - 7  USB 2.0 connectors (2)** — Connect to USB devices that are connected occasionally such as memory keys, digital cameras, and MP3 players.
  - 8 Optical drive eject buttons (2)** — Press the marked portion on the lower end of the button to eject the disc tray.
  - 9  Hard drive activity light** — Turns on when the computer reads or writes data. A blinking white light indicates hard drive activity.
-  **CAUTION: To avoid loss of data, never turn off the computer while the hard drive activity light is blinking.**



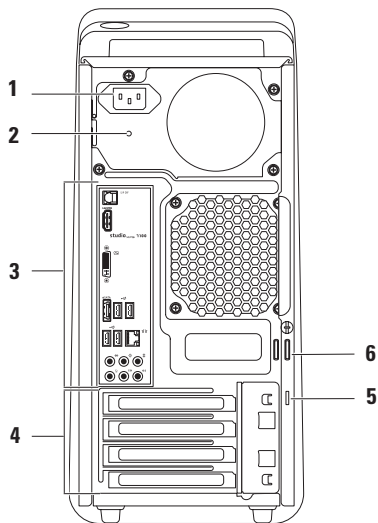

## Back View Features



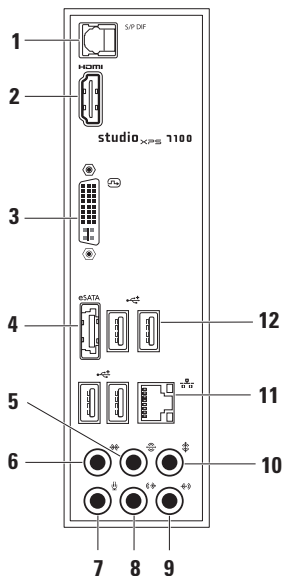





- 1 Power connector** — Connects to the power cable. The appearance of this connector may vary.
- 2 Power supply light** — Indicates power availability on the power supply unit.  
**NOTE:** The power supply light may not be available on all computers.
- 3 Back panel connectors** — Connect USB, audio, video, and other devices to the appropriate connectors.
- 4 Expansion card slots** — Provide access to connectors on any installed PCI and PCI Express cards.
- 5 Security cable slot** — Attaches a commercially available security cable to your computer.  
**NOTE:** Before you buy a security cable, ensure that it fits into the security cable slot on your computer.
- 6 Padlock rings** — Attach a standard padlock to prevent unauthorized access to the interior of your computer.

## Back Panel Connectors







-  **S/PDIF connector** — Connects to amplifiers of TVs for digital audio through optical digital cables. This format carries an audio signal without going through an analog audio conversion process.
-  **HDMI connector** — Connects to a TV for both audio and video signals.  
**NOTE:** For a monitor without built-in speakers, only the video signal will be read.
-  **DVI connector** — Connects to a monitor or projector.
-  **eSATA connector** — Connects to external SATA storage devices.
-  **Rear L/R surround connector** — Connects to rear L/R surround speakers.

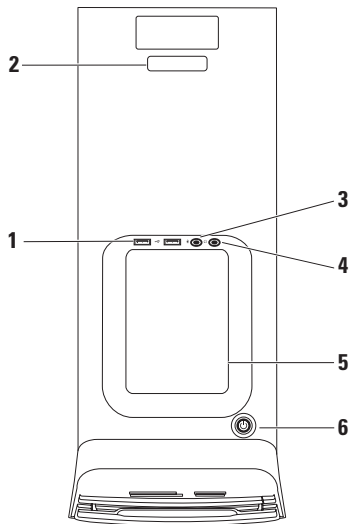

- 6  **Side L/R surround connector** — Connects to side L/R surround speakers.
- 7  **Microphone connector** — Connects to a microphone for voice or audio input into a sound or telephony program.
- 8  **Front L/R line-out connector** — Connects to front L/R speakers.
- 9  **Line-in connector** — Connects to recording or playback devices such as a microphone, cassette player, CD player, or VCR.
- 10  **Center/subwoofer connector** — Connects to a center speaker or subwoofer.
- 11  **Network connector and light** — Connects your computer to a network or broadband device. The network activity light blinks when the computer is transmitting or receiving data. A high volume of network traffic may make this light appear to be in a steady “on” state.
- 12  **USB 2.0 connectors (4)** — Connect to USB devices, such as a mouse, keyboard, printer, external drive, or MP3 player.

## Top View Features



-  **USB 2.0 connectors (2)** — Connect to USB devices that are connected occasionally such as memory keys, digital cameras, and MP3 players.
- Service Tag and Express Service Code** — Used to identify your computer when you access the Dell Support website or call technical support.
-  **Microphone or line-in connector** — Connects to a microphone for voice or to an audio cable for audio input.
-  **Headphone connector** — Connects to headphones.  
**NOTE:** To connect to a powered speaker or sound system, use the audio out or S/PDIF connector on the back of your computer.
- Accessory tray** — Used to place devices or secure cables to avoid clutter.

-  **Power button and light** — Turns the computer on or off when pressed. The light in the center of this button indicates the power state:
  - Off — The computer is either in hibernate mode, turned off or is not receiving power.
  - Solid white — The computer is on.
  - Solid amber — The computer is in sleep state or there may be a problem with either the system board or the power supply.
  - Blinking amber — There may be a problem with either the system board or the power supply.

**NOTE:** For information on power problems, see “Power Problems” on page 31.

## Software Features

 **NOTE:** For more information about the features described in this section, see the *Dell Technology Guide* available on your hard drive or at [support.dell.com/manuals](http://support.dell.com/manuals).

### Productivity and Communication

You can use your computer to create presentations, brochures, greeting cards, fliers, and spreadsheets. You can also edit and view digital photographs and images. Check your purchase order for software installed on your computer.

After connecting to the Internet, you can access websites, setup an e-mail account, and upload or download files.

### Entertainment and Multimedia

You can use your computer to watch videos, play games, create your own CDs, listen to music and radio stations. Your optical disc drive may support multiple disc media formats including CDs, DVDs, and Blu-ray Discs (if the option is selected at the time of purchase).

You can download or copy pictures and video files from portable devices, such as digital cameras and cell phones. Optional software applications enable you to organize and create music and video files that can be recorded to a disc, saved on portable products such as MP3 players and handheld entertainment devices, or played and viewed directly on connected TVs, projectors, and home theater equipment.

## Dell Dock

The Dell Dock is a group of icons that provides easy access to frequently-used applications, files, and folders. You can personalize the Dock by:

- Adding or removing icons
- Changing the color and location of the Dock
- Grouping related icons into categories
- Changing the behavior of the icons



### Add a Category

1. Right-click the Dock, click **Add**→ **Category**.  
The **Add/Edit Category** window is displayed.
2. Enter a title for the category in the **Title** field.
3. Select an icon for the category from the **Select an image:** box.
4. Click **Save**.

### Add an Icon

Drag and drop the icon to the Dock or a category.

### Remove a Category or Icon

1. Right-click the category or icon on the Dock and click **Delete shortcut** or **Delete category**.
2. Follow the instructions on the screen.

### Personalize the Dock

1. Right-click the Dock and click **Advanced Setting....**
2. Choose the desired option to personalize the Dock.

## Dell DataSafe Online Backup

 **NOTE:** Dell DataSafe Online may not be available in all regions.

 **NOTE:** A broadband connection is recommended for fast upload/download speeds.

Dell DataSafe Online is an automated backup and recovery service that helps protect your data and other important files from catastrophic incidents like theft, fire, or natural disasters. You can access the service on your computer using a password-protected account.

For more information, go to **[delldatasafe.com](http://delldatasafe.com)**.

To schedule backups:

1. Double-click the Dell DataSafe Online icon  on the taskbar.
2. Follow the instructions that appear on the screen.

# Solving Problems

This section provides troubleshooting information for your computer. If you cannot solve your problem using the following guidelines, see “Using Support Tools” on page 36 or “Contacting Dell” on page 57.

## Beep Codes

Your computer might emit a series of beeps during start-up if there are errors or problems. This series of beeps, called a beep code, identifies a problem. Write down the beep code and contact Dell (see “Contacting Dell” on page 57).

| Beep Code | Possible Problem  |
|-----------|---|
| One       | Possible system board failure — BIOS ROM checksum failure   |
| Two       | No RAM detected<br><b>NOTE:</b> If you installed or replaced the memory module, ensure that the memory module is seated properly. |
| Three     | Possible system board failure — Chipset error   |
| Four      | RAM read/write failure  |
| Five      | Real Time Clock failure   |
| Six       | Video card or chip failure  |

## Network Problems

### Wireless Connections

**If the network connection is lost** — The wireless router is offline or wireless has been disabled on the computer.

- Check your wireless router to ensure it is powered on and connected to your data source (cable modem or network hub).
- Re-establish your connection to the wireless router (see “Setting Up a Wireless Connection” on page 16).

### Wired Connections

**If the network connection is lost** —

- Check the cable to ensure it is plugged in and not damaged.
- Check the status of the link integrity light.

The link integrity light on the integrated network connector lets you verify that your connection is working and provides information on the status:

- Off — The computer is not detecting a physical connection to the network.
- Green — A good connection exists between a 10/100-Mbps network and the computer.
- Amber — A good connection exists between a 1000-Mbps network and the computer.

 **NOTE:** The link integrity light on the network connector is only for the wired cable connection. The link integrity light does not provide status for wireless connections.



## Power Problems

**If the power light is off** — The computer is either turned off or is not receiving power.

- Reseat the power cable into the power connector on the computer and the electrical outlet.
- If the computer is plugged into a power strip, ensure that the power strip is plugged into an electrical outlet and that the power strip is turned on.
- Bypass power protection devices, power strips, and power extension cables to verify that the computer turns on properly.
- Ensure that the electrical outlet is working by testing it with another device, such as a lamp.
- Ensure that the power supply light on the back of the computer is on. If the light is off there may be a possible problem with the power supply or the power cable.

If the problem persists, contact Dell (see “Contacting Dell” on page 57).

**If the power light is solid white and the computer is not responding** — The display may not be connected or powered on. Ensure that the display is properly connected and then turn it off, then back on.

**If the power light is solid amber** —

- The computer is in sleep or standby state. Press a key on the keyboard, move the connected mouse, or press the power button to resume normal operation.
- There may be a problem with either the system board or the power supply. For assistance, contact Dell (see “Contacting Dell” on page 57).

## Solving Problems

**If the power light is blinking amber** — There may be a problem with the system board.

For assistance, contact Dell (see “Contacting Dell” on page 57).

**If you encounter interference that hinders reception on your computer** — An unwanted signal is creating interference by interrupting or blocking other signals. Some possible causes of interference are:

- Power, keyboard, and mouse extension cables.
- Too many devices connected to a power strip.
- Multiple power strips connected to the same electrical outlet.

## Memory Problems

**If you receive an insufficient memory message** —

- Save and close any open files and exit any open programs you are not using to see if that resolves the problem.
- See the software documentation for minimum memory requirements. If necessary, install additional memory (see the *Service Manual* at [support.dell.com/manuals](http://support.dell.com/manuals)).
- Reseat the memory modules (see the *Service Manual* at [support.dell.com/manuals](http://support.dell.com/manuals)) to ensure that your computer is successfully communicating with the memory.

**If you experience other memory problems —**

- Ensure that you are following the memory installation guidelines (see the *Service Manual* at [support.dell.com/manuals](http://support.dell.com/manuals)).
- Check if the memory module is compatible with your computer. Your computer supports DDR3 memory. For more information about the type of memory supported by your computer, see “Specifications” on page 60.
- Run the Dell Diagnostics (see “Dell Diagnostics” on page 40).
- Reseat the memory modules (see the *Service Manual* at [support.dell.com/manuals](http://support.dell.com/manuals)) to ensure that your computer is successfully communicating with the memory.

## Lockups and Software Problems

**If the computer does not start up —** Ensure that the power cable is firmly connected to the computer and to the electrical outlet.

**If a program stops responding —** End the program:

1. Press <Ctrl><Shift><Esc> simultaneously.
2. Click **Applications**.
3. Click the program that is no longer responding
4. Click **End Task**.

## Solving Problems

**If a program crashes repeatedly** — Check the software documentation. If necessary, uninstall and then reinstall the program.

 **NOTE:** Software usually includes installation instructions in its documentation or on CD.

**If the computer stops responding or a solid blue screen appears** —

 **CAUTION:** You might lose data if you are unable to perform an operating system shutdown.

If you are unable to get a response by pressing a key on your keyboard or moving your mouse, press and hold the power button for at least 8 to 10 seconds until the computer turns off. Then restart your computer.

**If a program is designed for an earlier Microsoft Windows operating system** — Run the Program Compatibility Wizard. The Program Compatibility Wizard configures a program so that it runs in an environment similar to an earlier version of Microsoft® Windows® operating system environments.

1. Click **Start**  → **Control Panel** → **Programs** → **Run programs made for previous versions of Windows**.
2. In the welcome screen, click **Next**.
3. Follow the instructions on the screen.

**If you have other software problems —**

- Back up your files immediately.
  - Use a virus-scanning program to check the hard drive or CDs.
  - Save and close any open files or programs and shut down your computer through the **Start**  menu.
  - Check the software documentation or contact the software manufacturer for troubleshooting information:
    - Ensure that the program is compatible with the operating system installed on your computer.
    - Ensure that your computer meets the minimum hardware requirements needed to run the software. See the software documentation for information.
- Ensure that the program is installed and configured properly.
  - Verify that the device drivers do not conflict with the program.
  - If necessary, uninstall and then reinstall the program.

# Using Support Tools

## Dell Support Center

The Dell Support Center helps you find the service, support, and system-specific information you need.

To launch the application, click the  icon in the taskbar.

The **Dell Support Center** home page displays your computer's model number, service tag, express service code, and service contact information.

The home page also provides links to access:

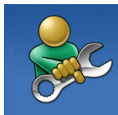

**Self Help** (Troubleshooting, Security, System Performance, Network/Internet, Backup/Recovery, and Windows operating system)



**Alerts** (technical support alerts relevant to your computer)



**Assistance from Dell** (Technical Support with DellConnect™, Customer Service, Training and Tutorials, How-To Help with Solution Station™, and Online Scan with PC CheckUp)



**About Your System** (System Documentation, Warranty Information, System Information, Upgrades & Accessories)

For more information about **Dell Support Center** and available support tools, click the **Services** tab on [support.dell.com](http://support.dell.com).

## My Dell Downloads

 **NOTE:** My Dell Downloads may not be available in all regions.

Some of the software pre-installed on your new computer do not include a backup CD or DVD. This software is available at My Dell Downloads. From this website you can download available software for reinstallation or create your own backup media.

To register and use My Dell Downloads:

1. Go to **[downloadstore.dell.com/media](https://downloadstore.dell.com/media)**.
2. Follow the instructions on the screen to register and download the software.
3. Reinstall or create backup media of the software for future use.

## System Messages

If your computer has an issue or error, it may display a system message that will help you identify the cause and action needed to resolve the issue.

 **NOTE:** If the message that is displayed is not listed in the following examples, see the documentation for either the operating system or the program that was running when the message appeared. Alternatively you could see the *Dell Technology Guide* on your hard drive or at **[support.dell.com/manuals](https://support.dell.com/manuals)** or see “Contacting Dell” on page 57 for assistance.

**Alert! Previous attempts at booting this system have failed at checkpoint [nnnn]. For help in resolving this problem, please note this checkpoint and contact Dell Technical Support** — The computer failed to complete the boot routine three consecutive times for the same error (see “Contacting Dell” on page 57 for assistance).

**CMOS checksum error** — Possible system board failure or RTC battery low. Battery needs replacement. See the *Service Manual* at [support.dell.com/manuals](http://support.dell.com/manuals) or see “Contacting Dell” on page 57 for assistance.

**CPU fan failure** — CPU fan has failed. CPU fan needs replacement. See the *Service Manual* at [support.dell.com/manuals](http://support.dell.com/manuals).

**CPU fan failure** — CPU fan has failed. CPU fan needs replacement. See the *Service Manual* at [support.dell.com/manuals](http://support.dell.com/manuals).

**Hard-disk drive failure** — Possible hard-disk drive failure during HDD POST. See “Contacting Dell” on page 57 for assistance.

**Hard-disk drive read failure** — Possible hard-disk drive failure during HDD boot test. See “Contacting Dell” on page 57 for assistance.

**Keyboard failure** — Replace keyboard or check the cable for loose connection.

**No boot device available** — No bootable partition on hard drive, the hard drive cable is loose, or no bootable device exists.

- If the hard drive is your boot device, ensure that the cables are connected and that the drive is installed properly and partitioned as a boot device.
- Enter system setup and ensure that the boot sequence information is correct. See the *Service Manual* at [support.dell.com/manuals](http://support.dell.com/manuals).

**No timer tick interrupt** — A chip on the system board might be malfunctioning or system board failure. See the *Service Manual* at [support.dell.com/manuals](http://support.dell.com/manuals) or see “Contacting Dell” on page 57 for assistance.



**USB over current error** — Disconnect the USB device. Your USB device needs more power for it to function properly. Use an external power source to connect the USB device, or if your device has two USB cables, connect both of them.

**NOTICE - Hard Drive SELF MONITORING SYSTEM has reported that a parameter has exceeded its normal operating range. Dell recommends that you back up your data regularly. A parameter out of range may or may not indicate a potential hard drive problem** — S.M.A.R.T error, possible hard drive failure. See “Contacting Dell” on page 57 for assistance.

## Hardware Troubleshooter

If a device is either not detected during the operating system setup or is detected but incorrectly configured, you can use the **Hardware Troubleshooter** to resolve the incompatibility.

To start the Hardware Troubleshooter:

1. Click **Start**  → **Help and Support**.
2. Type `hardware troubleshooter` in the search field and press <Enter> to start the search.
3. In the search results, select the option that best describes the problem and follow the remaining troubleshooting steps.

### Dell Diagnostics

If you experience a problem with your computer, perform the checks in “Lockups and Software Problems” on page 33 and run the Dell Diagnostics before you contact Dell for technical assistance.

It is recommended that you print these procedures before you begin.

 **NOTE:** Dell Diagnostics works only on Dell computers.

 **NOTE:** The *Drivers and Utilities* disc is optional and may not ship with your computer.

See the System Setup section in the *Service Manual* to review your computer’s configuration information, and ensure that the device that you want to test displays in the system setup program and is active.

Start the Dell Diagnostics from your hard drive or from the *Drivers and Utilities* disc.

### Starting Dell Diagnostics From Your Hard Drive

The Dell Diagnostics is located on a hidden diagnostic utility partition on your hard drive.

 **NOTE:** If your computer cannot display a screen image, contact Dell (see “Contacting Dell” on page 57).

1. Ensure that the computer is connected to an electrical outlet that is known to be working properly.
2. Turn on (or restart) your computer.
3. When the DELL™ logo appears, press <F12> immediately. Select **Diagnostics** from the boot menu and press <Enter>.

This may invoke the Pre-Boot System Assessment (PSA) on your computer.

 **NOTE:** If you wait too long and the operating system logo appears, continue to wait until you see the Microsoft® Windows® desktop; then, shut down your computer and try again.

 **NOTE:** If you see a message stating that no diagnostics utility partition has been found, run the Dell Diagnostics from the *Drivers and Utilities* disc.

*If PSA is invoked:*

- a. The PSA starts running tests.
- b. If the PSA completes successfully, the following message is displayed: `No problems have been found with this system so far. Do you want to run the remaining memory tests? This will take about 30 minutes or more. Do you want to continue? (Recommended).`

- c. If you are experiencing memory issues press <y>, otherwise press <n>. The following message is displayed: `Booting Dell Diagnostic Utility Partition. Press any key to continue.`
- d. Press any key to go to the **Choose An Option** window.

*If PSA is not invoked:*



Press any key to start the Dell Diagnostics from the diagnostics utility partition on your hard drive and go to the **Choose An Option** window.

4. Select the test you want to run.
5. If a problem is encountered during a test, a message appears with an error code and a description of the problem. Write down the error code and problem description and contact Dell (see “Contacting Dell” on page 57).

## Using Support Tools

-  **NOTE:** The Service Tag for your computer is displayed at the top of each test screen. If you contact Dell, technical support will ask for your Service Tag.
- 6. When the tests are complete, close the test screen to return to the **Choose An Option** window.
- 7. To exit the Dell Diagnostics and restart the computer, click **Exit**.

## Starting Dell Diagnostics From the Drivers and Utilities Disc

1. Insert the *Drivers and Utilities* disc.
2. Shut down and restart the computer. When the DELL™ logo appears, press <F12> immediately.
  -  **NOTE:** If you wait too long and the operating system logo appears, continue to wait until you see the Microsoft® Windows® desktop; then, shut down your computer and try again.
  -  **NOTE:** The next steps change the boot sequence for one time only. On the next start-up, the computer boots according to the devices specified in the system setup program.
3. When the boot device list appears, highlight **CD/DVD/CD-RW** and press <Enter>.

4. Select the **Boot from CD-ROM** option from the menu that appears and press <Enter>.
  5. Type 1 to start the CD menu and press <Enter> to proceed.
  6. Select **Run the 32 Bit Dell Diagnostics** from the numbered list. If multiple versions are listed, select the version appropriate for your computer.
  7. Select the test you want to run.
  8. If a problem is encountered during a test, a message appears with an error code and a description of the problem. Write down the error code and problem description and contact Dell (see “Contacting Dell” on page 57).
-  **NOTE:** The Service Tag for your computer is displayed at the top of each test screen. If you contact Dell, technical support will ask for your Service Tag.
9. When the tests are complete, close the test screen to return to the **Choose An Option** window.
  10. To exit the Dell Diagnostics and restart the computer, click **Exit**.
  11. Remove the *Drivers and Utilities* disc.

# Restoring Your Operating System

You can restore the operating system on your computer using any of the following options:

 **CAUTION:** Using Dell Factory Image Restore or the *Operating System* disc permanently deletes all data files on your computer. If possible, backup your data files before using these options.

| Option                       | Use   |
|------------------------------|---|
| System Restore               | as the first solution   |
| Dell DataSafe Local Backup   | when System Restore does not resolve your problem   |
| System recovery media        | when operating system failure prevents the use of System Restore and DataSafe Local Backup<br>when installing the factory image on a newly installed hard drive |
| Dell Factory Image Restore   | to restore your computer to the operating state it was in when you received your computer   |
| <i>Operating System</i> disc | to reinstall only the operating system on your computer   |

 **NOTE:** The *Operating System* disc may not ship with your computer.

## System Restore

The Windows operating systems provide a System Restore option which allows you to restore your computer to an earlier operating state (without affecting data files) if changes to the hardware, software, or other system settings have left the computer in an undesirable operating state. Any changes that System Restore makes to your computer are completely reversible.

 **CAUTION:** Make regular backups of your data files. System Restore does not monitor your data files or recover them.

 **NOTE:** The procedures in this document are applicable for the Windows default view, so they may not apply if you set your Dell™ computer to the Windows Classic view.

### Starting System Restore

1. Click **Start** .
2. In the **Start Search** box, type `System Restore` and press <Enter>.

 **NOTE:** The **User Account Control** window may appear. If you are an administrator on the computer, click **Continue**; otherwise, contact your administrator to continue the desired action.

3. Click **Next** and follow the remaining prompts on the screen.

In the event that System Restore did not resolve the issue, you may undo the last system restore.

### Undoing the Last System Restore

 **NOTE:** Before you undo the last system restore, save and close all open files, and exit any open programs. Do not alter, open, or delete any files or programs until the system restoration is complete.

1. Click **Start** .
2. In the **Start Search** box, type `System Restore` and press <Enter>.
3. Click **Undo my last restoration** and click **Next**.

# Dell DataSafe Local Backup

 **CAUTION:** Using Dell DataSafe Local Backup permanently removes any programs or drivers installed after you received your computer. Prepare backup media of applications you need to install on your computer before using Dell DataSafe Local Backup. Use Dell DataSafe Local Backup only if System Restore did not resolve your operating system problem.

 **CAUTION:** Although Dell Datasafe Local Backup is designed to preserve the data files on your computer, it is recommended that you backup your data files before using the Dell DataSafe Local Backup.

 **NOTE:** Dell DataSafe Local Backup may not be available in all regions.

 **NOTE:** If Dell DataSafe Local Backup is not available on your computer, use Dell Factory Image Restore (see “Dell Factory Image Restore” on page 49) to restore your operating system.

You can use Dell DataSafe Local Backup to restore your hard drive to the operating state it was in when you purchased your computer, while preserving the data files.

Dell DataSafe Local Backup allows you to:

- Backup and restore your computer to an earlier operating state
- Create system recovery media

## Dell DataSafe Local Backup Basic

To restore the factory image while preserving the data files:

1. Turn off your computer.
2. Disconnect all the devices (USB drive, printer, etc.) connected to the computer and remove any newly added internal hardware.

 **NOTE:** Do not disconnect the display, keyboard, mouse, or the power cable.

3. Turn on your computer.





4. When the DELL™ logo appears, press <F8> several times to access the **Advanced Boot Options** window.

 **NOTE:** If you wait too long and the operating system logo appears, continue to wait until you see the Microsoft® Windows® desktop; then, shut down your computer and try again.

5. Select **Repair Your Computer**.

6. Select **Dell DataSafe Restore and Emergency Backup** from the **System Recovery Options** menu and follow the instructions on the screen.

 **NOTE:** The restoration process may take an hour or more depending on the size of the data to be restored.

 **NOTE:** For more information, see the knowledge base article 353560 at [support.dell.com](http://support.dell.com).

## Upgrading to Dell DataSafe Local Backup Professional

 **NOTE:** Dell DataSafe Local Backup Professional may be installed on your computer, if you ordered it at the time of purchase.

Dell DataSafe Local Backup Professional provides additional features that allow you to:

- Backup and restore your computer based on file types
- Backup files to a local storage device
- Schedule automated backups

To upgrade to Dell DataSafe Local Backup Professional:

1. Double-click the Dell DataSafe Local Backup icon  on the taskbar.
2. Click **UPGRADE NOW!**
3. Follow the instructions on the screen to complete the upgrade.

# System Recovery Media

 **CAUTION:** Although the system recovery media is designed to preserve the data files on your computer, it is recommended that you backup your data files before using the system recovery media.

You can use the system recovery media, created using Dell DataSafe Local Backup, to return your hard drive to the operating state it was in when you purchased the computer while persevering the data files on your computer.

Use the system recovery media in case of:

- Operating system failure that prevents the use of recovery options that are installed on your computer.
- Hard drive failure that prevents data from being recovered.

To restore the factory image of your computer using the system recovery media:

1. Insert the system recovery disc or USB key and restart the computer.
2. When the DELL™ logo appears, press <F12> immediately.

 **NOTE:** If you wait too long and the operating system logo appears, continue to wait until you see the Microsoft® Windows® desktop; then, shut down your computer and try again.

3. Select the appropriate boot device from the list and press <Enter>.
4. Follow the instructions on the screen to complete the recovery process.

## Dell Factory Image Restore

 **CAUTION:** Using Dell Factory Image Restore permanently deletes all data on the hard drive and removes any programs or drivers installed after you received your computer. If possible, back up the data before using this option. Use Dell Factory Image Restore only if System Restore did not resolve your operating system problem.

 **NOTE:** Dell Factory Image Restore may not be available in certain countries or on certain computers.

Use Dell Factory Image Restore only as the last method to restore your operating system. This option restores your hard drive to the operating state it was in when you purchased the computer. Any programs or files added since you received your computer—including data files—are permanently deleted from the hard drive. Data files include documents, spreadsheets, e-mail messages, digital photos,

music files, and so on. If possible, back up all data before using Factory Image Restore.

### Performing Dell Factory Image Restore

1. Turn on the computer.
2. When the DELL™ logo appears, press <F8> several times to access the **Advanced Boot Options** Window.

 **NOTE:** If you wait too long and the operating system logo appears, continue to wait until you see the Microsoft® Windows® desktop; then, shut down your computer and try again.

3. Select **Repair Your Computer**.  
The **System Recovery Options** window appears.
4. Select a keyboard layout and click **Next**.
5. To access the recovery options, log on as a local user. To access the command prompt, type `administrator` in the **User name** field, then click **OK**.

## Restoring Your Operating System

### 6. Click **Dell Factory Image Restore**.

The **Dell Factory Image Restore** welcome screen appears.

 **NOTE:** Depending upon your configuration, you may need to select **Dell Factory Tools**, then **Dell Factory Image Restore**.

### 7. Click **Next**. The **Confirm Data Deletion** screen appears.

 **NOTE:** If you do not want to proceed with Factory Image Restore, click **Cancel**.

### 8. Click the check box to confirm that you want to continue reformatting the hard drive and restoring the system software to the factory condition, then click **Next**.

The restore process begins and may take five or more minutes to complete. A message appears when the operating system and factory-installed applications have been restored to factory condition.

### 9. Click **Finish** to restart the computer.

# Getting Help

If you experience a problem with your computer, you can complete the following steps to diagnose and troubleshoot the problem:

1. See “Solving Problems” on page 29 for information and procedures that pertain to the problem your computer is experiencing.
2. See “Dell Diagnostics” on page 40 for procedures on how to run Dell Diagnostics.
3. Fill out the “Diagnostic Checklist” on page 56.
4. Use Dell’s extensive suite of online services available at Dell Support ([support.dell.com](http://support.dell.com)) for help with installation and troubleshooting procedures. See “Online Services” on page 52 for a more extensive list of Dell Support online.
5. If the preceding steps have not resolved the problem, see “Contacting Dell” on page 57.

 **NOTE:** Call Dell Support from a telephone near or at the computer so that the support staff can assist you with any necessary procedures.

 **NOTE:** Dell’s Express Service Code system may not be available in all countries.

When prompted by Dell’s automated telephone system, enter your Express Service Code to route the call directly to the proper support personnel. If you do not have an Express Service Code, open the **Dell Accessories** folder, double-click the **Express Service Code** icon, and follow the directions.

 **NOTE:** Some of the following services are not always available in all locations outside the continental U.S. Call your local Dell representative for information on availability.

## Technical Support and Customer Service

Dell's support service is available to answer your questions about Dell hardware. Our support staff uses computer-based diagnostics to provide fast, accurate answers.

To contact Dell's support service, see "Before You Call" on page 56 and then see the contact information for your region or go to [support.dell.com](http://support.dell.com).

### DellConnect

DellConnect™ is a simple online access tool that allows a Dell service and support associate to access your computer through a broadband connection, diagnose your problem, and repair it all under your supervision. For more information, go to [support.dell.com/dellconnect](http://support.dell.com/dellconnect).

## Online Services

You can learn about Dell products and services on the following websites:

- [www.dell.com](http://www.dell.com)
- [www.dell.com/ap](http://www.dell.com/ap) (Asian/Pacific countries only)
- [www.dell.com/jp](http://www.dell.com/jp) (Japan only)
- [www.euro.dell.com](http://www.euro.dell.com) (Europe only)
- [www.dell.com/la](http://www.dell.com/la) (Latin American and Caribbean countries)
- [www.dell.ca](http://www.dell.ca) (Canada only)

You can access Dell Support through the following websites and e-mail addresses:

### Dell Support websites

- [support.dell.com](mailto:support.dell.com)
- [support.jp.dell.com](mailto:support.jp.dell.com) (Japan only)
- [support.euro.dell.com](mailto:support.euro.dell.com) (Europe only)

## Dell Support e-mail addresses

- **mobile\_support@us.dell.com**
- **support@us.dell.com**
- **la-techsupport@dell.com** (Latin America and Caribbean countries only)
- **apsupport@dell.com** (Asian/Pacific countries only)

## Dell Marketing and Sales e-mail addresses

- **apmarketing@dell.com** (Asian/Pacific countries only)
- **sales\_canada@dell.com** (Canada only)

## Anonymous file transfer protocol (FTP)

- **ftp.dell.com**

Log in as user: `anonymous`, and use your e-mail address as your password.

## Automated Order-Status Service

To check on the status of any Dell products that you have ordered, you can go to **support.dell.com**, or you can call the automated order-status service. A recording prompts you for the information needed to locate and report on your order. For the telephone number to call your region, see “Contacting Dell” on page 57.

If you have a problem with your order, such as missing parts, wrong parts, or incorrect billing, contact Dell for customer assistance. Have your invoice or packing slip handy when you call. For the telephone number to call for your region, see “Contacting Dell” on page 57.

## Product Information



If you need information about additional products available from Dell, or if you would like to place an order, visit the Dell website at **www.dell.com**. For the telephone number to call for your region or to speak to a sales specialist, see “Contacting Dell” on page 57.

## Returning Items for Repair Under Warranty or for Credit

Prepare all items being returned, whether for repair or credit, as follows:

-  **NOTE:** Before you return the product to Dell, make sure to back up any data on the hard drive and on any other storage device in the product. Remove any and all confidential, proprietary and personal information, as well as removable media, such as CDs and media cards. Dell is not responsible for any of your confidential, proprietary or personal information; lost or corrupted data; or damaged or lost removable media that may be included with your return.



1. Call Dell to obtain a Return Material Authorization Number, and write it clearly and prominently on the outside of the box. For the telephone number to call for your region, see “Contacting Dell” on page 57.
2. Include a copy of the invoice and a letter describing the reason for the return.
3. Include a copy of the Diagnostics Checklist (see “Diagnostic Checklist” on page 56), indicating the tests that you have run and any error messages reported by the Dell Diagnostics (see “Dell Diagnostics” on page 40).
4. Include any accessories that belong with the item(s) being returned (power cables, software, guides, and so on) if the return is for credit.
5. Pack the equipment to be returned in the original (or equivalent) packing materials.
  -  **NOTE:** You are responsible for paying shipping expenses. You are also responsible for insuring any product returned, and you assume the risk of loss during shipment to Dell. Collect On Delivery (C.O.D.) packages are not accepted.
  -  **NOTE:** Returns that are missing any of the preceding requirements will be refused at Dell’s receiving dock and returned to you.

## Before You Call

 **NOTE:** Have your Express Service Code ready when you call. The code helps Dell's automated-support telephone system direct your call more efficiently. You may also be asked for your Service Tag (located on a label on top of your computer).

Remember to fill out the following Diagnostics Checklist. If possible, turn on your computer before you call Dell for assistance and call from a telephone at or near the computer. You may be asked to type some commands at the keyboard, relay detailed information during operations, or try other troubleshooting steps possible only at the computer itself. Ensure that the computer documentation is available.

### Diagnostic Checklist

- Name:
- Date:
- Address:
- Phone number:
- Service Tag and Express Service Code (located on a label on top of your computer):
- Return Material Authorization Number (if provided by Dell support technician):
- Operating system and version:
- Devices:
- Expansion cards:
- Are you connected to a network? Yes/No
- Network, version, and network adapter:
- Programs and versions:

See your operating system documentation to determine the contents of the computer's start-up files. If the computer is connected to a printer, print each file. Otherwise, record the contents of each file before calling Dell.

- Error message, beep code, or diagnostic code:
- Description of problem and troubleshooting procedures you performed:

## Contacting Dell

For customers in the United States, call 800-WWW-DELL (800-999-3355).

 **NOTE:** If you do not have an active Internet connection, you can find contact information on your purchase invoice, packing slip, bill, or Dell product catalog.

Dell provides several online and telephone-based support and service options. Availability varies by country and product, and some services may not be available in your area.

To contact Dell for sales, technical support, or customer service issues:

1. Visit **[www.dell.com/contactdell](http://www.dell.com/contactdell)**.
2. Select your country or region.
3. Select the appropriate service or support link based on your requirement.
4. Choose the method of contacting Dell that is convenient for you.

# Finding More Information and Resources

**If you need to:**

---

reinstall your operating system

---

run a diagnostic program for your computer

---

reinstall desktop system software

---

find more information about the Microsoft®  
Windows® operating system and features

---

upgrade your computer with new or additional  
memory, or a new hard drive

---

reinstall or replace a worn or defective part

**See:**

---

“System Recovery Media” on page 48

---

“Dell Diagnostics” on page 40

---

“My Dell Downloads” on page 37

---

**support.dell.com**

---

the *Service Manual* at **support.dell.com/manuals**



**NOTE:** In some countries, opening and replacing parts of your computer may void your warranty. Check your warranty and return policies before working inside your computer.

---

### If you need to:

find safety best practices information for your computer

review Warranty information, Terms and Conditions (U.S. only), Safety instructions, Regulatory information, Ergonomics information, and End User License Agreement

find your Service Tag/Express Service Code — You must use the Service Tag to identify your computer on [support.dell.com/manuals](http://support.dell.com/manuals) or to contact technical support

find drivers and downloads; readme files  
access technical support and product help  
check on your order status for new purchases  
find solutions and answers to common questions

locate information for last-minute updates about technical changes to your computer or advanced technical-reference material for technicians or experienced users

### See:



the safety information that is shipped with your computer, before working inside your computer. For additional safety best practices information, see the Regulatory Compliance Homepage at [www.dell.com/regulatory\\_compliance](http://www.dell.com/regulatory_compliance).

the top of your computer  
the Dell Support Center. To launch the Dell Support Center, click the  icon in the taskbar.

the Dell Support website at [support.dell.com](http://support.dell.com)

# Specifications

This section provides information that you may need when setting up, updating drivers for, and upgrading your computer.

 **NOTE:** Offerings may vary by region. For more information regarding the configuration of your computer, click **Start**  → **Help and Support** and select the option to view information about your computer.

## Computer Model

---

Studio XPS™ 7100

## Processor

---

|       |                                  |
|-------|----------------------------------|
| Types | AMD Phenom™ II<br>AMD Athlon™ II |
|-------|----------------------------------|

## Computer Information

---

|                   |   |
|-------------------|---|
| System chipset    | AMD RS785 + SB710                       |
| RAID support      | RAID 0 (striping)<br>RAID 1 (mirroring) |
| Data bus width    | 16 bits                                 |
| DRAM bus width    | 64 bits                                 |
| BIOS chip (NVRAM) | 8 MB                                    |

## Memory

---

|                         |  |
|-------------------------|--|
| Connectors              | four internally accessible DDR3 DIMM sockets |
| Memory type             | 1333-MHz DDR3 DIMMs; non-ECC memory only     |
| Configurations possible | 2 GB, 4 GB, 6 GB, 8 GB, 12 GB, and 16 GB     |
| Minimum                 | 2 GB   |
| Maximum                 | 16 GB  |

 **NOTE:** For instructions on upgrading memory, see the *Service Manual* at [support.dell.com/manuals](http://support.dell.com/manuals).

## Audio

---

|      |   |
|------|---|
| Type | Integrated 7.1 channel; High Definition audio with S/PDIF support |
|------|---|

## Drives

---

|                       |   |
|-----------------------|---|
| Externally accessible | two 5.25-inch bays for SATA DVD+/-RW Super Multi Drive or Blu-ray Disc™ combo (optional) or Blu-ray Disc RW drive (optional)<br><br>one 3.5 inch bay for a Flexdock |
| Internally accessible | two 3.5-inch bays for SATA hard drives  |

## Video

---

|            |                              |
|------------|------------------------------|
| Integrated | ATI Radeon™ HD 4200 Graphics |
| Discrete   | PCI Express x16 card         |

## Communication

---

|                     |                                      |
|---------------------|--------------------------------------|
| Wireless (optional) | Wi-Fi/Bluetooth® wireless technology |
|---------------------|--------------------------------------|

## Specifications

### Expansion Bus

---

|             |  |
|-------------|--|
| PCI Express | Gen2 x1 slot bi-directional speed — 1 GB/s<br>Gen2 x16 slot bi-directional speed — 16 GB/s |
| PCI         | 32-bit speed — 33 MHz  |
| SATA 2.0    | 1.5 Gbps and 3.0 Gbps  |
| USB 2.0     | high speed — 480 Mbps<br>full speed — 12 Mbps<br>low speed — 1.2 Mbps                      |

### Physical

---

|        |                          |
|--------|--------------------------|
| Height | 407.75 mm (16.02 inches) |
| Width  | 185.81 mm (7.31 inches)  |
| Depth  | 454.67 mm (17.9 inches)  |
| Weight | 10.18 kg (22.4 lb)       |

### Memory Card Reader

---

|                 |   |
|-----------------|---|
| Cards supported | CompactFlash (CF) card<br>Smart Media (SM) card<br>xD-Picture (xD) card<br>Memory Stick (MS) card<br>Memory Stick Duo card<br>Memory Stick PRO Duo card<br>Memory Stick PRO (MSPRO) card<br>Memory Stick PRO HG (MSPRO HG) card<br>SecureDigital (SD) card<br>SecureDigital Card (SDHC) 2.0<br>MultiMedia Card (MMC)<br>MicroDrive (MD) |
|-----------------|---|



**External Connectors**

|                 |  |
|-----------------|--|
| Network adapter | RJ45 connector   |
| USB             | two top-panel, two front-panel, and four back-panel USB 2.0 compliant connectors               |
| Audio           | top panel — microphone and headphone connectors<br>back panel — six connectors for 7.1 support |
| S/PDIF          | one digital S/PDIF (optical) connector   |
| eSATA           | one back-panel connector   |
| DVI             | one 29-pin connector   |
| HDMI            | one 19-pin connector   |

**System Board Connectors**

|                       |   |
|-----------------------|---|
| Memory                | four 240-pin connectors                                       |
| PCI                   | one 124-pin connector   |
| PCI Express x1        | two 36-pin connectors   |
| PCI Express x16       | one 164-pin connector   |
| Power (system board)  | one 24-pin EPS 12 V connector                                 |
| Chassis fan           | two 3-pin connectors  |
| Processor fan         | one 4-pin connector   |
| USB connectors        | four 9-pin connectors   |
| Front audio connector | one 9-pin connector for 2-channel stereo sound and microphone |
| SATA                  | five 7-pin connectors   |
| S/PDIF out            | one 5-pin connector   |

## Specifications

### Expansion Slots

---

#### PCI

|                                |                   |
|--------------------------------|-------------------|
| Connectors                     | one               |
| Connector size                 | 124-pin connector |
| Connector data width (maximum) | 32 bit            |

#### PCI Express x1

|                                |                    |
|--------------------------------|--------------------|
| Connectors                     | two                |
| Connector size                 | 36-pin connector   |
| Connector data width (maximum) | 1 PCI Express lane |

#### PCI Express x16

|                                |                      |
|--------------------------------|----------------------|
| Connectors                     | one                  |
| Connector size                 | 164-pin connector    |
| Connector data width (maximum) | 16 PCI Express lanes |

### Power

---

#### DC Power Supply (460 W)

|                          |             |
|--------------------------|-------------|
| Maximum heat dissipation | 2413 BTU/hr |
|--------------------------|-------------|

**NOTE:** Heat dissipation is calculated by using the power supply wattage rating.

|                      |             |
|----------------------|-------------|
| Input voltage        | 115/230 VAC |
| Input frequency      | 50/60 Hz    |
| Rated output current | 8 A/4 A     |

### Battery

---

|                   |                              |
|-------------------|------------------------------|
| Coin-cell battery | 3 V CR2032 lithium coin cell |
|-------------------|------------------------------|

## Computer Environment

---

### Temperature range

|                             |                                |
|-----------------------------|--------------------------------|
| Operating                   | 10°C to 35°C (50°F to 95°F)    |
| Storage                     | -40°C to 65°C (-40°F to 149°F) |
| Relative humidity (maximum) | 20% to 80% (noncondensing)     |

### Maximum vibration (using a random-vibration spectrum that simulates user environment)

|           |           |
|-----------|-----------|
| Operating | 0.26 GRMS |
| Storage   | 2.2 GRMS  |

## Computer Environment

---

Maximum shock (for operating — measured with Dell Diagnostics running on the hard drive and a 2-ms half-sine pulse; for non-operating — measured with hard drive in head-parked position and a 26-ms half-sine pulse):

|               |   |
|---------------|---|
| Operating     | 40 G for 2 ms with a change in velocity of 20 in/s (51 cm/s)    |
| Non-Operating | 45 G for 26 ms with a change in velocity of 288 in/s (732 cm/s) |

### Altitude (maximum)

|           |   |
|-----------|---|
| Operating | -15.2 to 3048 m<br>(-50 to 10,000 ft)   |
| Storage   | -15.2 to 10,668 m<br>(-50 to 35,000 ft) |

Airborne contaminant level G2 or lower as defined by ISA-S71.04-1985

# Appendix

## Macrovision Product Notice

This product incorporates copyright protection technology that is protected by method claims of certain U.S. patents and other intellectual property rights owned by Macrovision Corporation and other rights owners. Use of this copyright protection technology must be authorized by Macrovision Corporation, and is intended for home and other limited viewing uses only unless otherwise authorized by Macrovision Corporation. Reverse engineering or disassembly is prohibited.

## Information for NOM, or Official Mexican Standard (only for Mexico)

The following information is provided in the device(s) described in this document in accordance with the requirements of the Official Mexican Standard (NOM):

**Importer:**

Dell México S.A. de C.V.

Paseo de la Reforma 2620 – Flat 11°

Col. Lomas Altas

11950 México, D.F.

| <b>Regulatory Model Number</b> | <b>Input Voltage</b> | <b>Input Frequency</b> | <b>Rated Output Current</b> |
|--------------------------------|----------------------|------------------------|-----------------------------|
| D03M                           | 115/230 V            | 50/60 Hz               | 8 A/4 A                     |

For details, read the safety information that shipped with your computer.

For additional safety best practices information, see the Regulatory Compliance Homepage at [www.dell.com/regulatory\\_compliance](http://www.dell.com/regulatory_compliance).

# Index

## C

- calling Dell **56**
- CDs, playing and creating **26**
- chipset **60**
- computer capabilities **26**
- connect(ing)
  - optional network cable **11**
- Contacting Dell online **57**
- customer service **52**

## D

- DataSafe Local Backup **46**
- DellConnect **52**
- Dell Diagnostics **40**
- Dell support website **59**

- drivers and downloads **59**
- DVDs, playing and creating **26**

## E

- eject button **19**
- email addresses
  - for technical support **53**
- Express Service Code **25, 51**

## F

- front-side connectors **18**
- FTP login, anonymous **53**

## H

- hard drive
  - type **61**
- hard drive activity light **19**

hardware problems

    diagnosing **39**

Hardware Troubleshooter **39**

## I

Internet connection **15**

ISP

    Internet Service Provider **15**

## M

memory problems

    solving **32**

memory support **61**

## N

network connection

    fixing **30**

network connector

    location **23**

## O

order status **53**

## P

power button and light **25**

power problems, solving **31**

problems, solving **29**

products

    information and purchasing **54**

## R

restoring factory image **49**

## S

security cable slot **21**

Service Tag **25, 56**

shipping products

    for return or repair **54**

software features **26**

## Index

- software problems **33**
- solving problems **29**
- support email addresses **53**
- support sites
  - worldwide **52**
- System Messages **37**
- System Recovery Media **48**

## T

- technical support **52**

## U

- USB 2.0
  - back connectors **23**
  - front connectors **19**

## W

- warranty returns **54**
- Windows
  - Program Compatibility Wizard **34**
- Windows, reinstalling **44**
- wireless network connection **30**







Printed in the U.S.A.

[www.dell.com](http://www.dell.com) | [support.dell.com](http://support.dell.com)



OKM04CA00